

MODULAR CONNECTORS

CL 222 TM

EMI-proof right angle dip type connectors

TM11R-5L *-88(50)

CL No.	Part No.	Type	RoHS
222-2667-3-50	TM11R-5L-88(50)	Standard	YES
222-2668-6-50	TM11R-5LF-88(50)	With ferrite core	

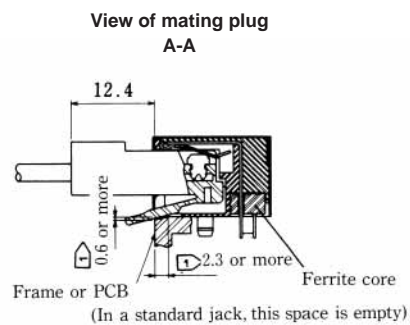
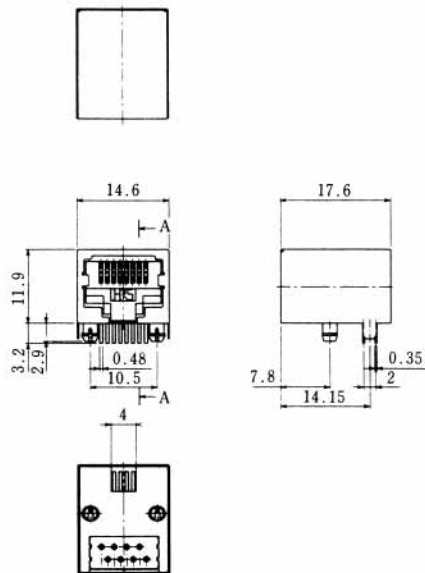
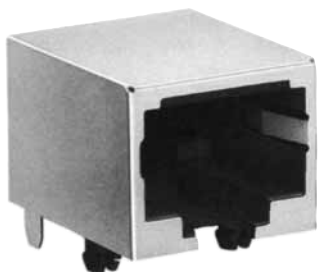

Reference mounting dimensions (PCB component side)

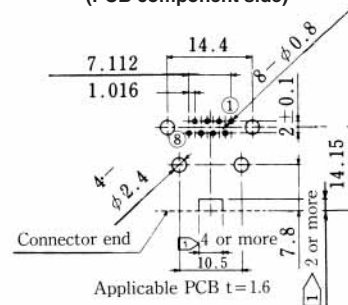

Note : When preparing frames or PCBs, provide the above for the connector.

EMI-proof quadruplet right angle dip type connectors

TM11R-5L *-3232(50)

CL No.	Part No.	Type	RoHS
222-2720-4-50	TM11R-5L-3232(50)	Standard	YES
222-2722-0-50	TM11R-5LF-3232(50)	With ferrite core	

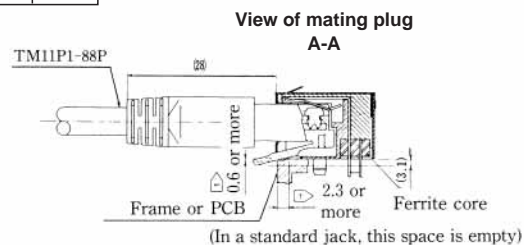
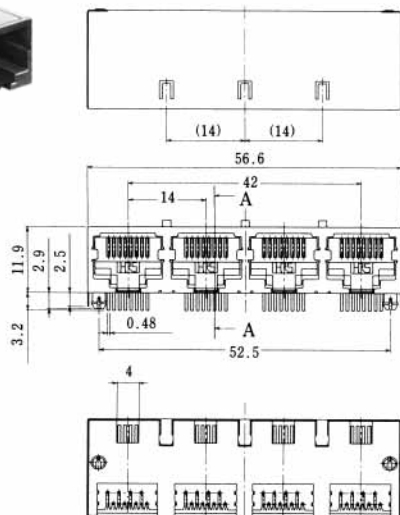

Reference mounting dimensions (PCB component side)

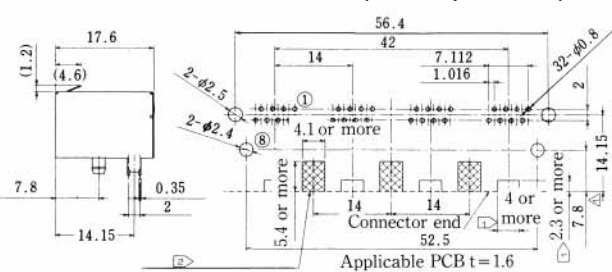

No pattern is allowed in this area

Note : When preparing frames or PCBs, provide the above for the connector.
 No pattern is allowed in the hatched area(s) on the connector side of the boards.

MODULAR CONNECTORS

CL 222 TM

EMI-PROTECTED JACKS

GENERAL

The EMI-protected modular connectors have been developed from the TM Series connectors, to resist noise. Designed to comply with the FCC (Federal Communications Commission) 68 Standard, they range from standard parts to EMI-protected parts.

Furthermore, they are highly operable and resistant to severe environmental conditions to ensure customer satisfaction with shielding performance.

FEATURES

- (1) Plug connectors have a single-body shell and clamp to ensure secure protection from EMI.
- (2) To prevent electrostatic problems, plug connectors are designed so that the metal shell can be covered with a plastic hood.
- (3) Jack connectors that allow the shielded parts to be connected first during mating to protect the circuits within the set.
- (4) Plug harnesses can be wired easily and securely with a special tool.
- (5) Eight-conductor plugs and jack connectors comply with the ISO 8877 Standard (ISDN interface connector).

MAIN APPLICATIONS

ISDN related equipment, HBS, mobile telephones, office automation equipment.

JACKS WITH LEAD WIRES

TM11R-88-35S-300

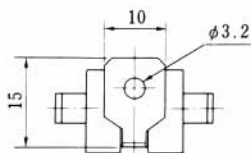

CL No.	Part No.	RoHS
222-4449-3	TM11R-88-35S-300M	YES

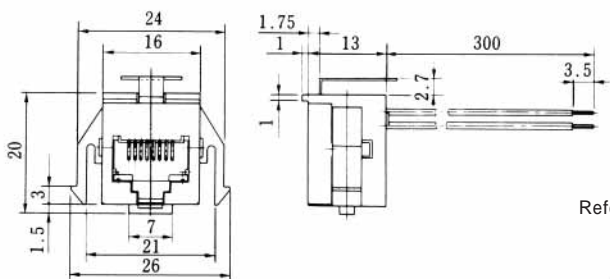

Reference mounting drawing

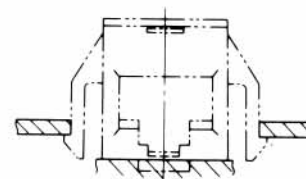

Standard color arrangement

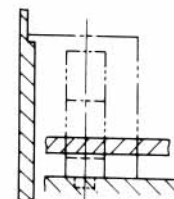
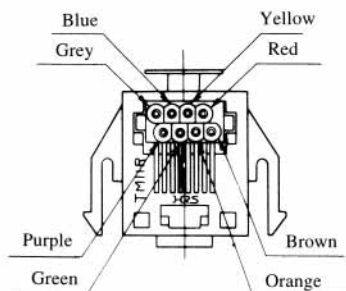

Note : Standard finish color is gray.

MODULAR CONNECTORS

CL 222 TM

Right angle dip type connectors

TM11R-5C-66

CL No.	Part No.	RoHS
222-2148-6-50	TM11R-5C-66(50)	YES

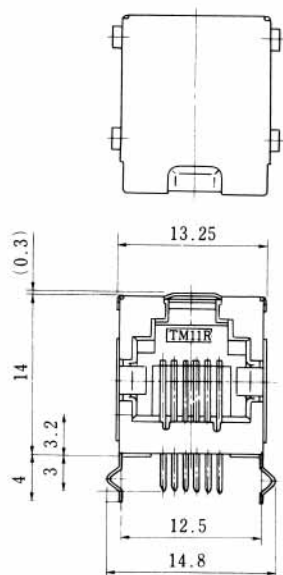
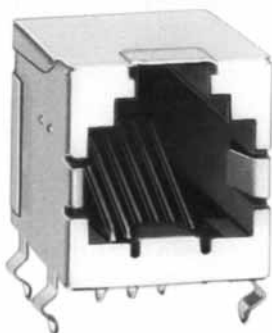

Board mounting dimensional drawing (connector side)

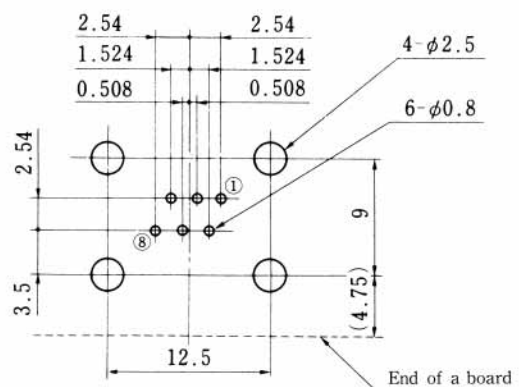

TM11R-5C-88

CL No.	Part No.	RoHS
222-1378-0-50	TM11R-5C-88(50)	YES

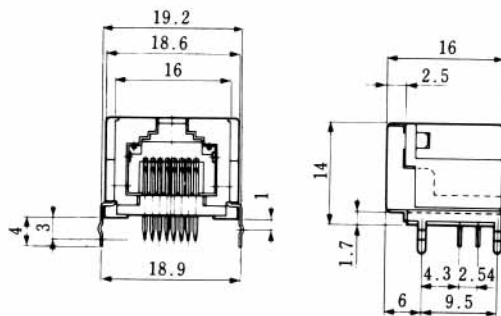
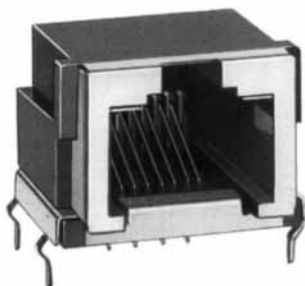
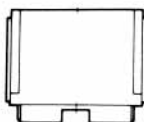

Board mounting dimensional drawing (connector side)

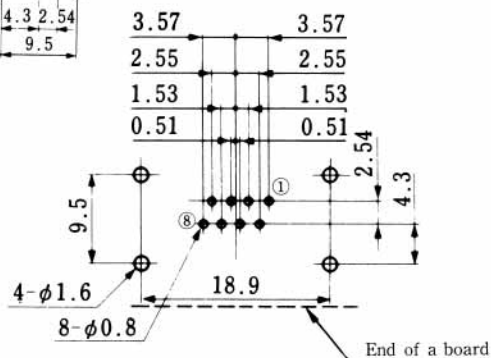

Note : Cover standard color is black.

MODULAR CONNECTORS

CL 222 TM

Right angle dip type connectors (With a decorative panel)

TM11R-5E1-88(50)

CL No.	Part No.	RoHS
222-3820-4-50	TM11R-5E1-88(50)	YES

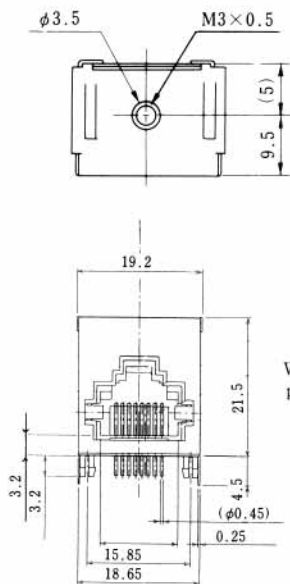
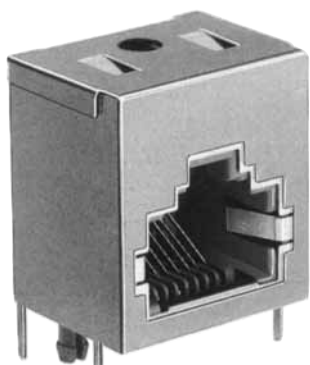

Board mounting dimensional drawing (connector side)

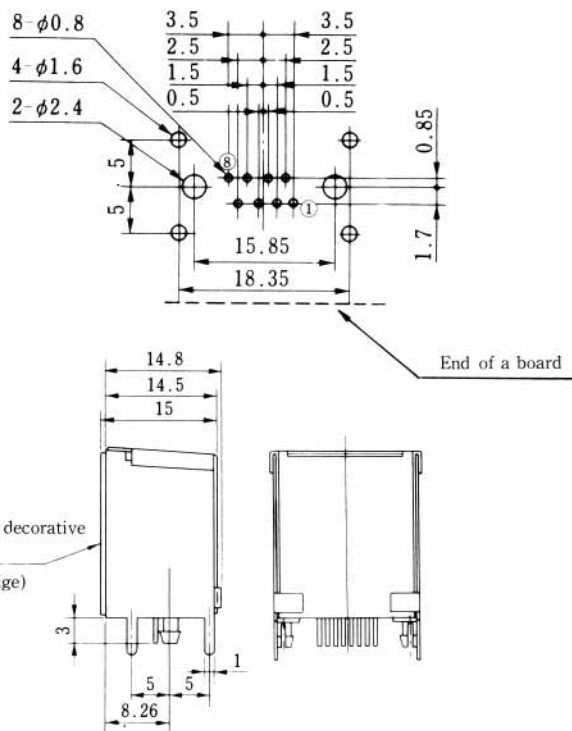

Straight dip type connectors

TM11R-3C-88(50)

CL No.	Part No.	RoHS
222-2133-9-50	TM11R-3C-88(50)	YES

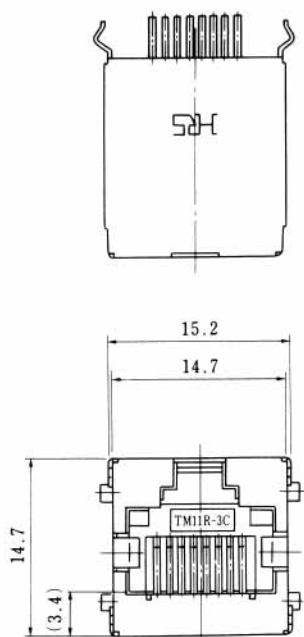
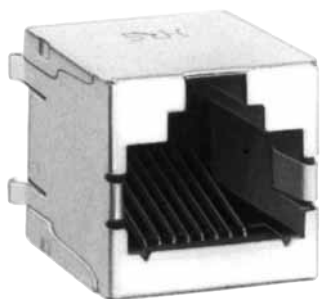

Board mounting dimensional drawing (connector side)

